



**LE-DS-L** is a double-sided suspended sign frame in a landscape configuration.

The LE-DS-L is an economy version using the LE-L offered in three height options: 55, 107 and 153mm (2", 4", 6") or as a perimeter frame using LEF frames in different sizes ranging between 75mm and 300mm ( 3" to 12").

Commonly used width options are presented; however, customized widths are available upon request.

The installation can be done by using our chrome plated auto lock adjustable cable grip ceiling anchors.

For sign frames with heights ranging between 55mm and 153mm (2" to 6") using the LE-L solid profiles, vinyl graphics can be applied directly on the profile's smooth flat face or printed paper with a clear lens cover.

For signs that use the LEF perimeter frames we offer two face options:

CC - A double-layer face: A lightweight thin opaque PVC sheet is used as a basic support face along with a clear polycarbonate cover lens.

DBP - A single layer face: A solid Dibond® composite aluminum board is fixed in frame, ready for direct application of vinyl graphics.

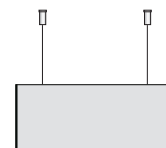

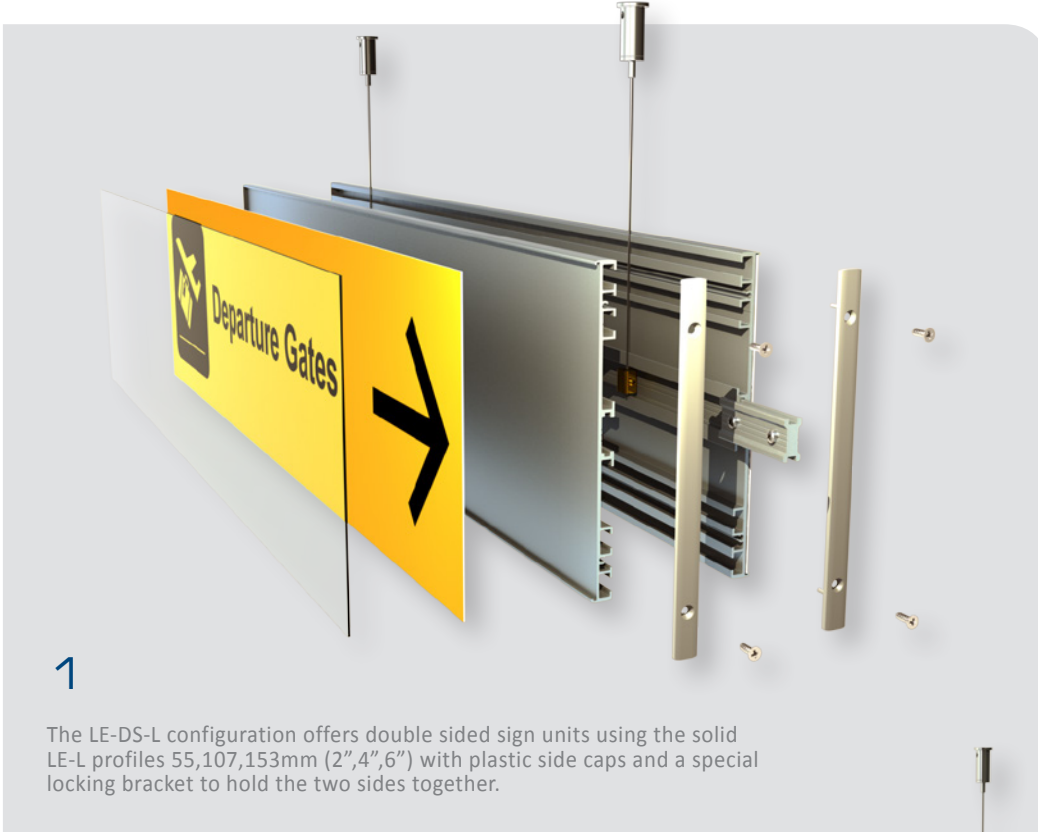

1

The LE-DS-L configuration offers double sided sign units using the solid LE-L profiles 55,107,153mm (2",4",6") with plastic side caps and a special locking bracket to hold the two sides together.



2

Installation can be done by using chrome plated auto lock cable grip ceiling anchors and PVC coated steel cable.

3

The LEF-DS-L configuration offers double sided sign units using the perimeter LEF frames with a composite aluminum board face. Sign units can be from a variety of sizes. The two sign units are attached using concealed screw.

LE-DS-L-H-W-EC	
LE	System Type - Leader Edge
DS	Double Sided
L	Sign layout - Landscape
H	Sign Unit Height - mm
W	Sign Unit Width - mm
EC	End caps finish <b>GR</b> - Grey <b>BK</b> - Black <b>CR</b> - Chrome Plated

## LE-DS-L-55

Commonly used unit width (other unit width can be ordered by demand)

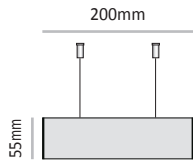

<b>Cat. No.</b>	LE-DS-L-55-200
<b>Unit Width</b>	200 mm
<b>Insert size</b>	52mm X 200mm

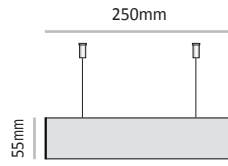

<b>Cat. No.</b>	LE-DS-L-55-250
<b>Unit Width</b>	250 mm
<b>Insert size</b>	52mm X 250mm

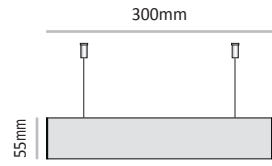

<b>Cat. No.</b>	LE-DS-L-55-300
<b>Unit Width</b>	300 mm
<b>Insert size</b>	52mm X 300mm

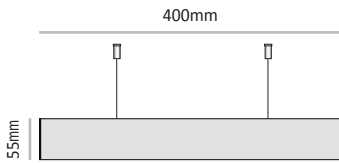

<b>Cat. No.</b>	LE-DS-L-55-400
<b>Unit Width</b>	400 mm
<b>Insert size</b>	52mm X 400mm

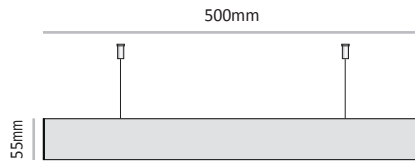

<b>Cat. No.</b>	LE-DS-L-55-500
<b>Unit Width</b>	500 mm
<b>Insert size</b>	52mm X 500mm

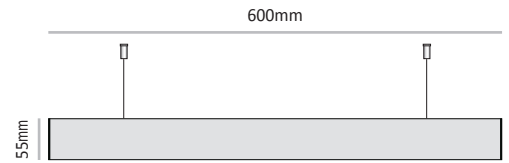

<b>Cat. No.</b>	LE-DS-L-55-600
<b>Unit Width</b>	600 mm
<b>Insert size</b>	52mm X 600mm

## LE-DS-L-107

Commonly used unit width (other unit width can be ordered by demand)

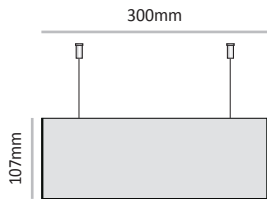

<b>Cat. No.</b>	LE-DS-L-107-300
<b>Unit Width</b>	300 mm
<b>Insert size</b>	105mm X 300mm

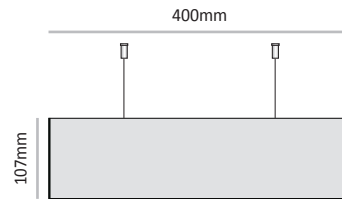

<b>Cat. No.</b>	LE-DS-L-107-400
<b>Unit Width</b>	400 mm
<b>Insert size</b>	105mm X 400mm

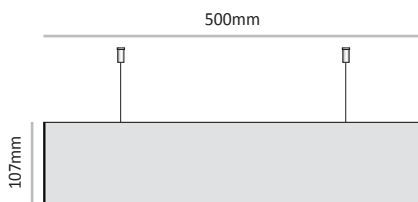

<b>Cat. No.</b>	LE-DS-L-107-500
<b>Unit Width</b>	500 mm
<b>Insert size</b>	105mm X 500mm

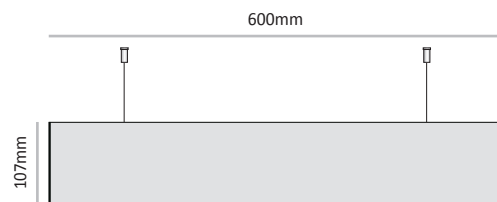

<b>Cat. No.</b>	LE-DS-L-107-600
<b>Unit Width</b>	600 mm
<b>Insert size</b>	105mm X 600mm

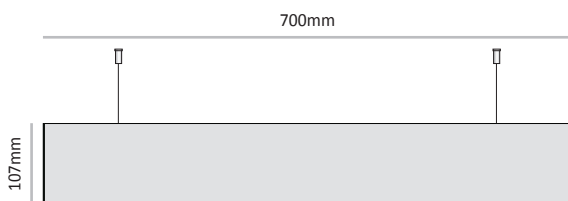

<b>Cat. No.</b>	LE-DS-L-107-700
<b>Unit Width</b>	700 mm
<b>Insert size</b>	105mm X 700mm

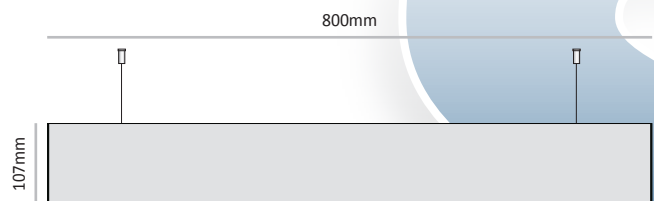

<b>Cat. No.</b>	LE-DS-L-107-800
<b>Unit Width</b>	800 mm
<b>Insert size</b>	105mm X 800mm

LE-DS-L-153

Commonly used unit width (other unit width can be ordered by demand)

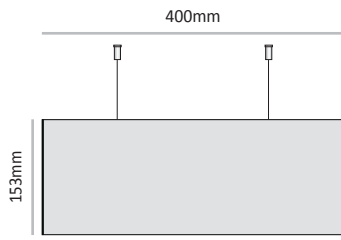

<b>Cat. No.</b>	LE-DS-L-153-400
<b>Unit Width</b>	400 mm
<b>Insert size</b>	150mm X 400mm

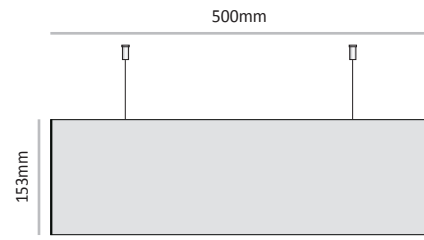

<b>Cat. No.</b>	LE-DS-L-153-500
<b>Unit Width</b>	500 mm
<b>Insert size</b>	150mm X 500mm

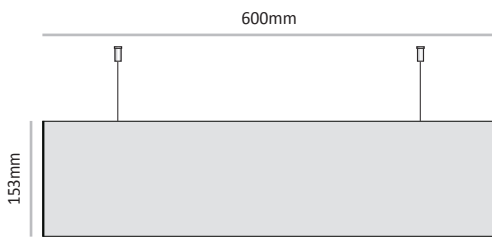

<b>Cat. No.</b>	LE-DS-L-153-600
<b>Unit Width</b>	600 mm
<b>Insert size</b>	150mm X 600mm

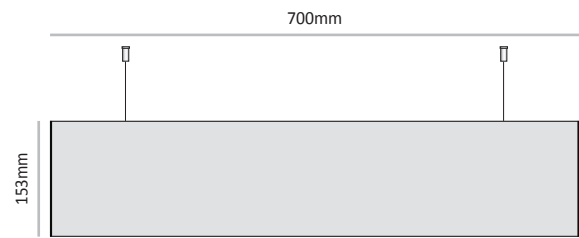

<b>Cat. No.</b>	LE-DS-L-153-700
<b>Unit Width</b>	700 mm
<b>Insert size</b>	150mm X 700mm

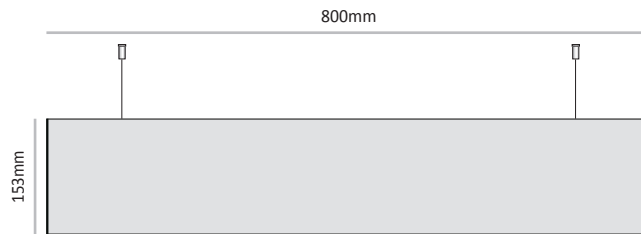

<b>Cat. No.</b>	LE-DS-L-153-800
<b>Unit Width</b>	800 mm
<b>Insert size</b>	150mm X 800mm

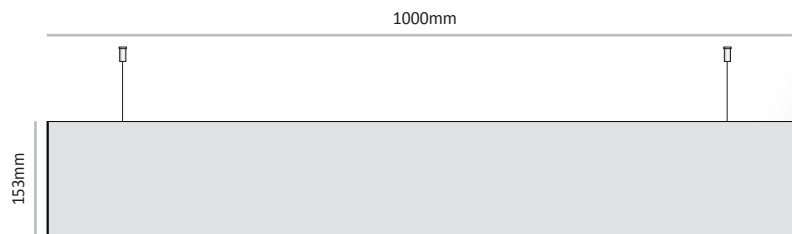

<b>Cat. No.</b>	LE-DS-L-153-1000
<b>Unit Width</b>	1000 mm
<b>Insert size</b>	150mm X 1000mm

LEF-DS-L-210

Commonly used unit width (other unit width can be ordered by demand)

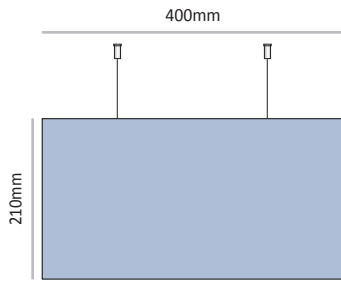

**Cat. No.** LEF-DS-L-210-400  
**Unit Size HxW** 210mm x 400mm

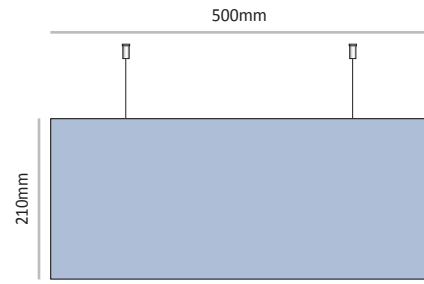

**Cat. No.** LEF-DS-L-210-500  
**Unit Size HxW** 210mm x 500mm

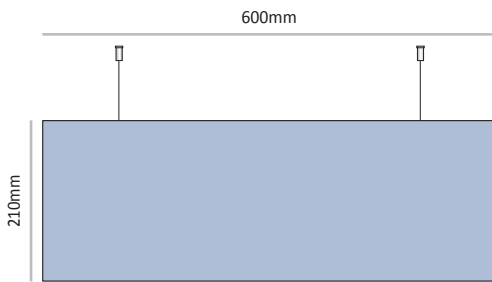

**Cat. No.** LEF-DS-L-210-600  
**Unit Size HxW** 210mm x 600mm

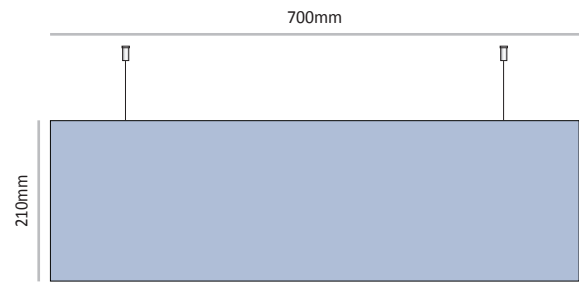

**Cat. No.** LEF-DS-L-210-700  
**Unit Size HxW** 210mm x 700mm

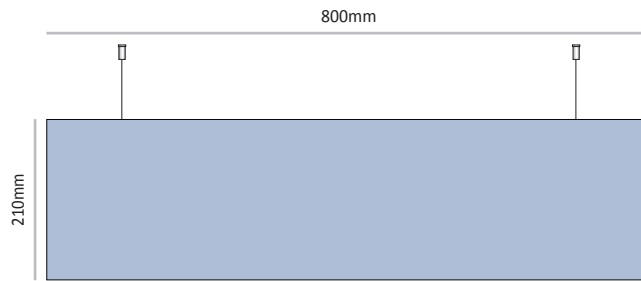

**Cat. No.** LEF-DS-L-210-800  
**Unit Size HxW** 210mm x 800mm

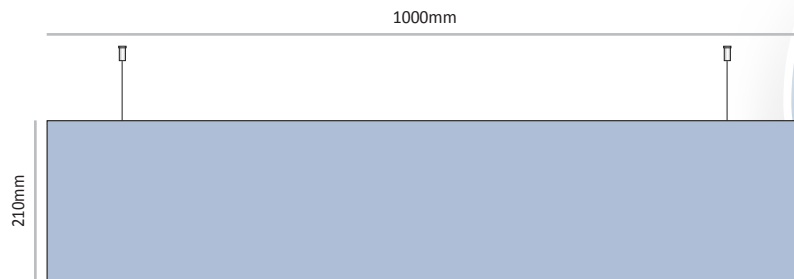

**Cat. No.** LEF-DS-L-210-1000  
**Unit Size HxW** 210mm x 1000mm

LEF-DS-L-300

Commonly used unit width (other unit width can be ordered by demand)

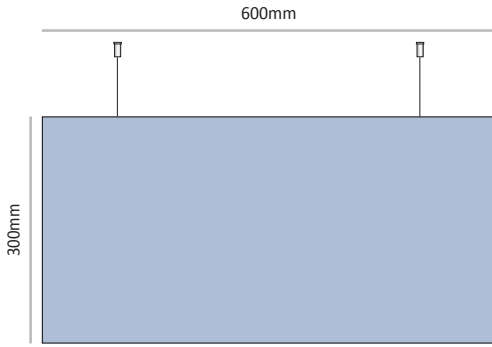

**Cat. No.** LEF-DS-L-300-600  
**Unit Size HxW** 300mm x 600mm

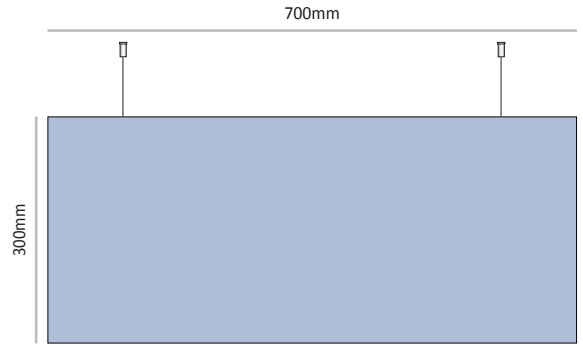

**Cat. No.** LEF-DS-L-300-700  
**Unit Size HxW** 300mm x 700mm

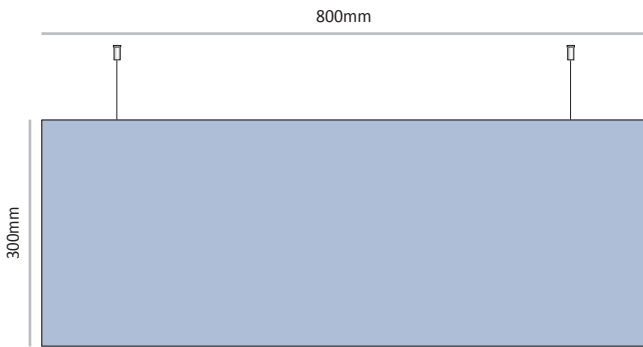

**Cat. No.** LEF-DS-L-300-800  
**Unit Size HxW** 300mm x 800mm

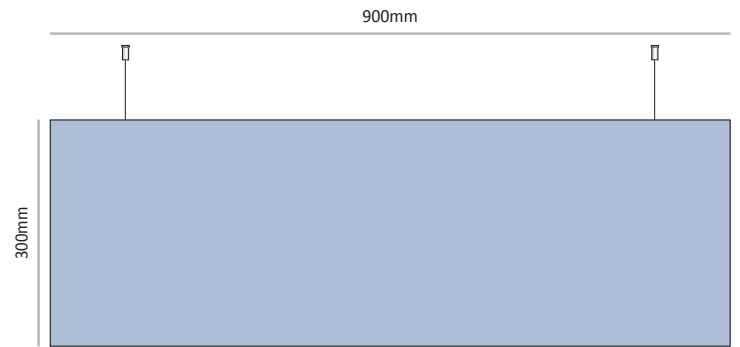

**Cat. No.** LEF-DS-L-300-900  
**Unit Size HxW** 300mm x 900mm

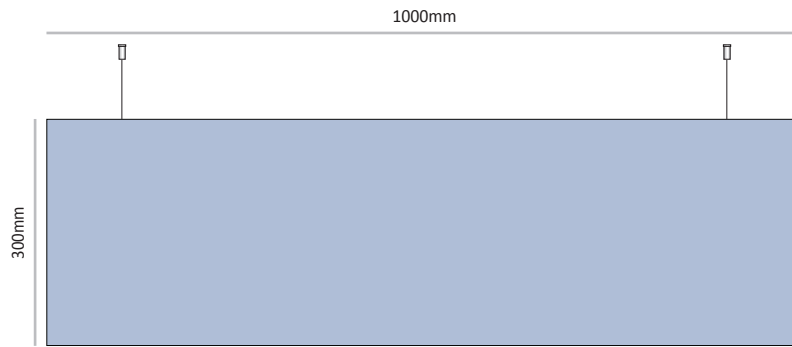

**Cat. No.** LEF-DS-L-300-1000  
**Unit Size HxW** 300mm x 1000mm

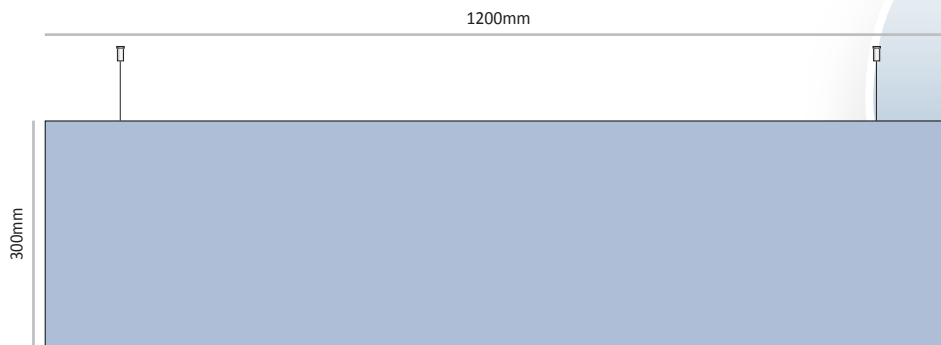

**Cat. No.** LEF-DS-L-300-1200  
**Unit Size HxW** 300mm x 1200mm



**LEF-D-DS-P** is a double-sided suspended directory sign frame in a portrait configuration.

The LEF-DS-D-P comes with silver anodized strips cut as requested to your specifications, placed on top of a back panel that is covered with a thin metal sheet using self-adhesive magnet strips.

Strips are easy to insert and remove using our silicone suction cup.

Three standard frame widths are offered: 400, 500 and 600mm (16", 20" and 24") in limitless height options.

Commonly used size options are presented; however, customized sizes are available upon request.

The installation can be done by using our chrome plated auto lock adjustable cable grip ceiling anchors.

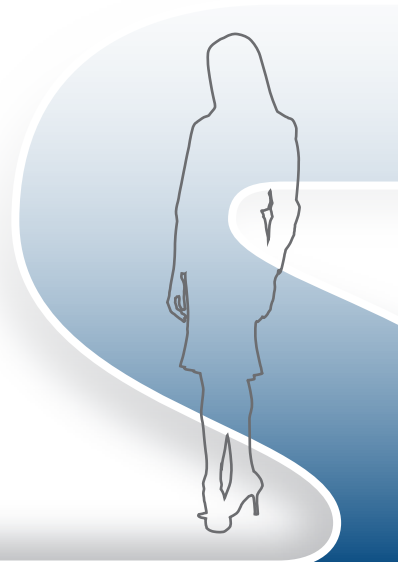
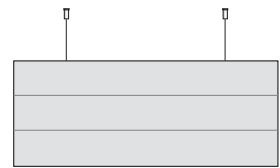



Installation can be done by using chrome plated auto lock cable grip ceiling anchors and PVC coated steel cable.

LEF-D-DS-P-W-H	
LEF	System Type - Leader Edge Frames
D	Directory
DS	Double Sided
P	Sign layout - Portarit
W	Sign Unit Width - mm
H	Sign Unit Height - mm



## LEF-D-DS-P-400

Commonly used unit height (other unit height can be ordered by demand)

*The number and measures of the strips can be ordered by demand.*

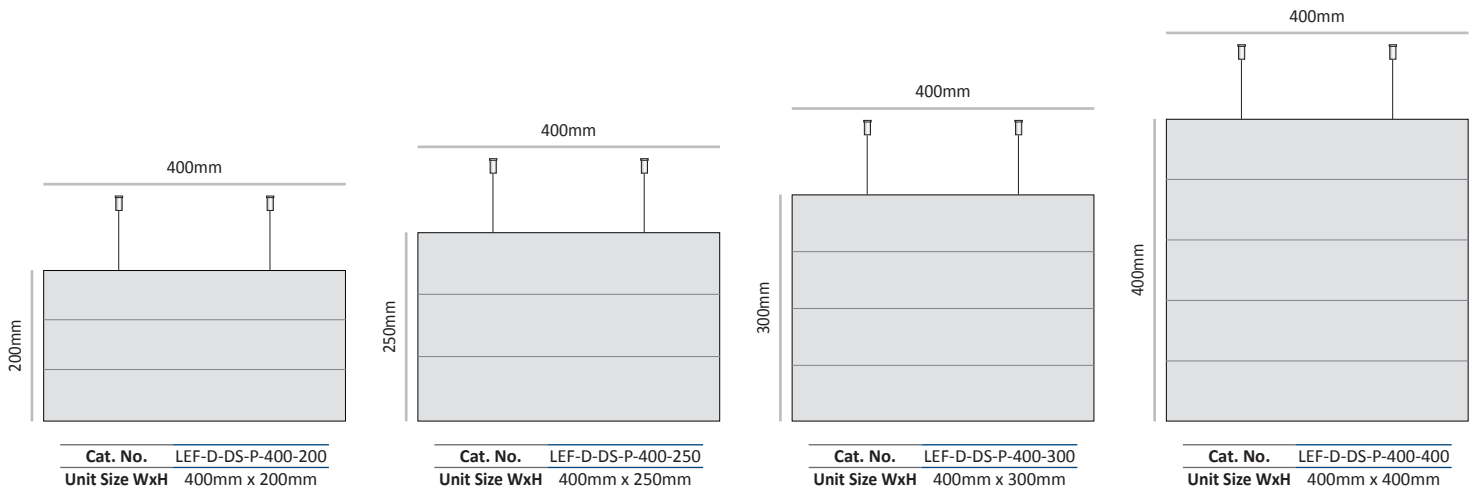

## LEF-D-DS-P-500

Commonly used unit height (other unit height can be ordered by demand)

*The number and measures of the strips can be ordered by demand.*

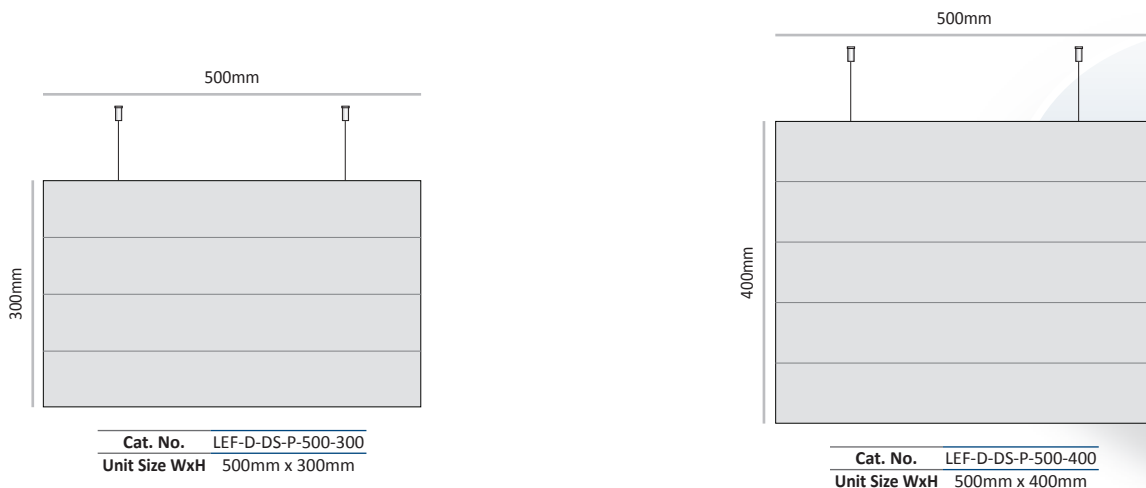
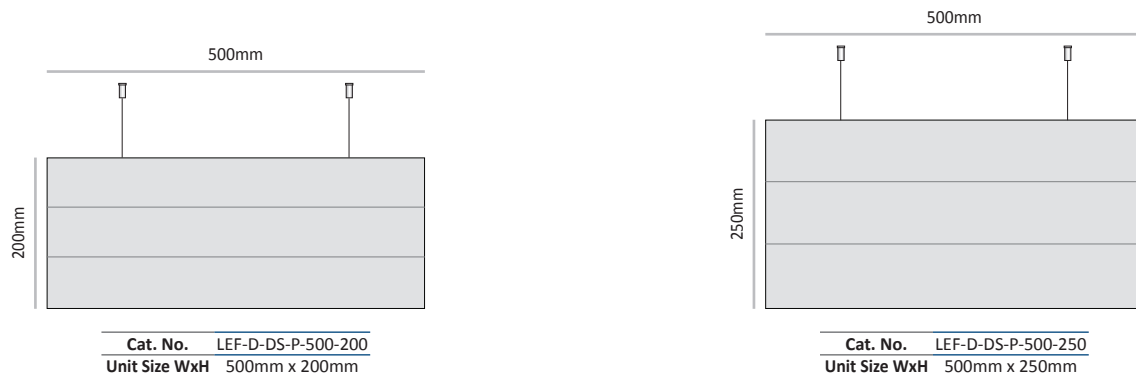

LEF-D-DS-P-600

Commonly used unit height (other unit height can be ordered by demand)

*The number and measures of the strips can be ordered by demand.*

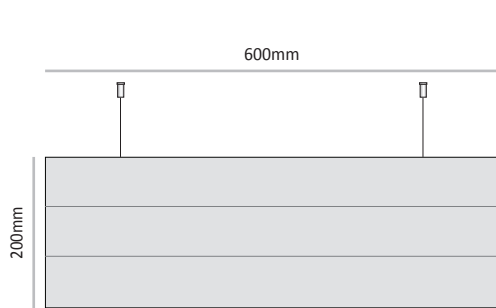

**Cat. No.** LEF-D-DS-P-600-200  
**Unit Size WxH** 600mm x 200mm

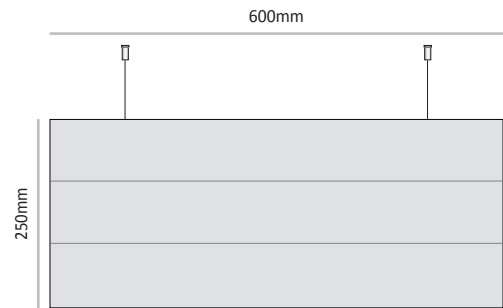

**Cat. No.** LEF-D-DS-P-600-250  
**Unit Size WxH** 600mm x 250mm

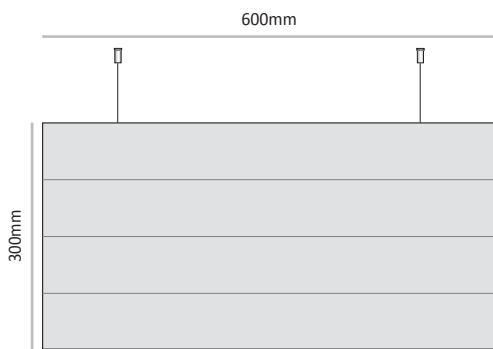

**Cat. No.** LEF-D-DS-P-600-300  
**Unit Size WxH** 600mm x 300mm

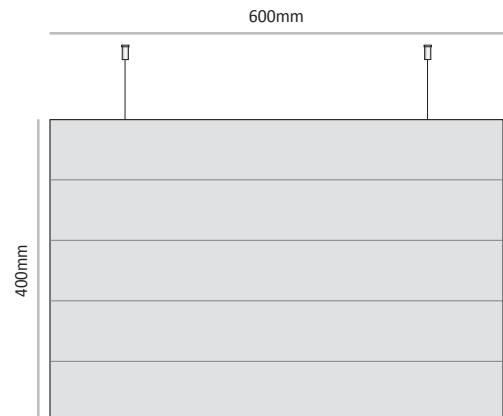

**Cat. No.** LEF-D-DS-P-600-400  
**Unit Size WxH** 600mm x 400mm